

GR30

Rotatore

Rotator **EN** | **FR** Rotateur
 Rotator **DE** | **ES** Rotadore

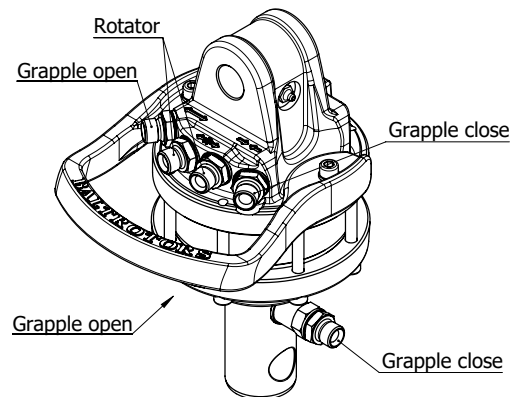
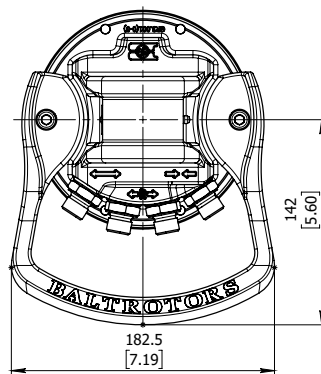
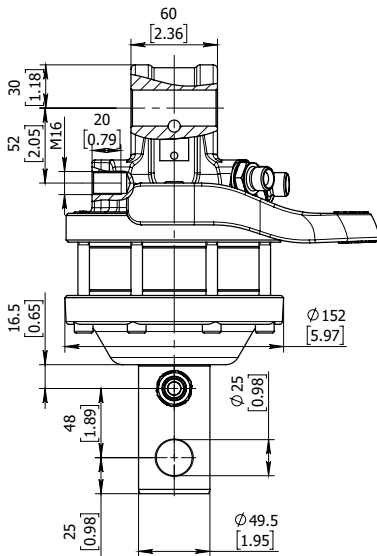
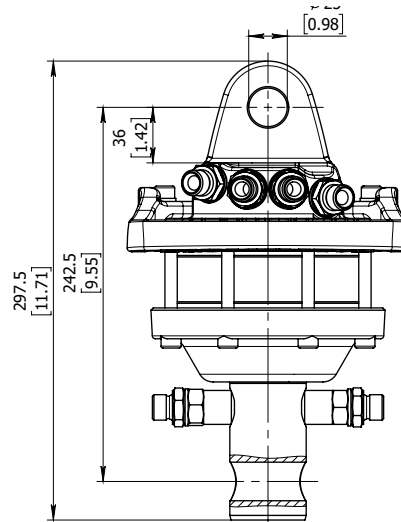

Informazioni Tecniche Technical data

Rotation	unlimited
Max axial load static, KN (lbf)	30 (6745)
Max axial load dynamic, KN (lbf)	15 (3372)
Torque at 25Mpa (3625psi), Nm (lb ft)	1000 (738)
Rec oilflow, l/min (US gallon)	20 (5.3)
Weight, kg (lb)	15 (33)

Massima pressione di lavoro Max working pressure

Rotator ←R→	Max 25 MPa (3625 psi)
Grapple / Tool Open ←G→	Max 20 MPa (2900 psi)
Grapple / Tool Close →G←	Max 25 MPa (4350 psi)

Connessione Connection

G 3/8
G 3/8
G 3/8

